

Home

Products

Distributors

Technical

Contact Us

Other Options

Path: [Home](#) > [Enclosure Index](#) > Diecast Aluminum - Light Duty Watertight (With Bottom Flange)



[click to enlarge](#)































[click to enlarge](#)



[click to enlarge](#)

### ***Key Features:***

- Rugged, diecast aluminum alloy (tough yet easy to machine), electronic instrument enclosure.
- Lid screws are exposed for easy enclosure access (if you require higher security see our [watertight flanged lid version](#)).
- Bottom flange is an aluminum plate, welded onto the base of the enclosure.
- Lap joint construction with a factory poured silicone rubber gasket around the perimeter of the lid provides protection against access of dust and water.
- Silicone rubber gasket remains flexible from -62 to +232°C (-80 to +450 °F).
- Unpainted version is vibra finished for a smooth surface with no sharp edges.
- Painted version is painted with tough polyester powder paint for a lasting finish, even after machining. Paint is only applied to the exterior surface. Black screws are included to enhance appearance.
- Four (or 6 in 1590D, 1590DD & 1590E, 8 in 1590F) 6-32 x 1/2" stainless steel machine screws secure lid - into factory tapped holes.
- Screws use neoprene "O" rings (included).
- Designed to meet IP65.
- Low side wall draft angle (2 degrees or less) for easy P.C. board mounting.
-  Link here to [photo tables](#) of each part number - **note:** regular, unflanged version shown for sizing

| Part Number                            | Color           | Reader File   |  Drawing File Size | AutoCAD .dwg File (zipped)   | .zip File Size | Units  | Length | Width | Enclosure Depth (Less Lid) |
|--|-----------------|---|---|--|----------------|--------|--------|-------|----------------------------|
| <b>1590WLLBF</b><br><b>1590WLLBFBK</b> | Unpainted Black |    | 133K  |    | 185K           | Inches | 1.97   | 1.97  | 0.83                       |
|  |                 |   |   |  |                | mm     | 50     | 50    | 21                         |
| <b>1590WLBF</b><br><b>1590WLBFBK</b>   | Unpainted Black |    | 141K  |    | 172K           | Inches | 1.99   | 1.99  | 1.06                       |
|  |                 |   |   |  |                | mm     | 51     | 51    | 27                         |
| <b>1590WHF</b><br><b>1590WHFBK</b>     | Unpainted Black |    | 145K  |    | 273K           | Inches | 2.07   | 1.5   | 1.06                       |
|  |                 |   |   |  |                | mm     | 52.5   | 38    | 27                         |
| <b>1590WYF</b><br><b>1590WYFBK</b>     | Unpainted Black |    | 121K  |    | 177K           | Inches | 3.62   | 3.62  | 1.50                       |
|  |                 |   |   |  |                | mm     | 92     | 92    | 38                         |
| <b>1590WAF</b><br><b>1590WAFBK</b>     | Unpainted Black |    | 129K  |    | 155K           | Inches | 3.64   | 1.52  | 1.06                       |
|  |                 |   |   |  |                | mm     | 93     | 39    | 27                         |
| <b>1590WGF</b><br><b>1590WGFBK</b>     | Unpainted Black |    | 136K  |    | 263K           | Inches | 3.94   | 1.97  | 0.83                       |
|  |                 |   |   |  |                | mm     | 100    | 50    | 21                         |
| <b>1590WSF</b><br><b>1590WSFBK</b>     | Unpainted Black |    | 135K  |    | 227K           | Inches | 4.35   | 3.21  | 1.57                       |
|  |                 |   |   |  |                | mm     | 111    | 82    | 40                         |
| <b>1590WBF</b><br><b>1590WBFBK</b>     | Unpainted Black |   | 128K  |   | 174K           | Inches | 4.39   | 2.34  | 1.06                       |
|  |                 |   |   |  |                | mm     | 112    | 60    | 27                         |
| <b>1590WBBF</b><br><b>1590WBBFBK</b>   | Unpainted Black |  | 166K  |  | 177K           | Inches | 4.67   | 3.68  | 1.18                       |
|  |                 |   |   |  |                | mm     | 119    | 94    | 30                         |
| <b>1590WQF</b><br><b>1590WQFBK</b>     | Unpainted Black |  | 132K  |  | 427K           | Inches | 4.70   | 4.70  | 1.1                        |
|  |                 |   |   |  |                | mm     | 120    | 120   | 28                         |
| <b>1590WUF</b><br><b>1590WUFBK</b>     | Unpainted Black |  | 124K  |  | 268K           | Inches | 4.70   | 4.70  | 2.17                       |
|  |                 |   |   |  |                | mm     | 120    | 120   | 55                         |
| <b>1590WVF</b><br><b>1590WVFBK</b>     | Unpainted Black |  | 118K  |  | 238K           | Inches | 4.70   | 4.70  | 3.54                       |
|  |                 |   |   |  |                | mm     | 120    | 120   | 90                         |
| <b>1590WCF</b><br><b>1590WCFBK</b>     | Unpainted Black |  | 128K  |  | 288K           | Inches | 4.72   | 3.70  | 2.07                       |
|  |                 |   |   |  |                | mm     | 120    | 94    | 53                         |

|                                      |                    |   |      |  |      |        |       |       |      |
|--------------------------------------|--------------------|---|------|--|------|--------|-------|-------|------|
| <b>1590WTF</b><br><b>1590WTFBK</b>   | Unpainted<br>Black |     | 133K |     | 211K | Inches | 4.74  | 3.13  | 2.17 |
|                                      |                    |   |      |  |      | mm     | 121   | 80    | 55   |
| <b>1590WN1F</b><br><b>1590WN1FBK</b> | Unpainted<br>Black |    | 125K |    | 244K | Inches | 4.77  | 2.6   | 1.39 |
|                                      |                    |   |      |  |      | mm     | 121.1 | 66    | 35.3 |
| <b>1590WKKF</b><br><b>1590WKKFBK</b> | Unpainted<br>Black |    | 123K |    | 214K | Inches | 4.92  | 4.92  | 2.10 |
|                                      |                    |   |      |  |      | mm     | 125   | 125   | 53   |
| <b>1590WKF</b><br><b>1590WKFBK</b>   | Unpainted<br>Black |    | 115K |    | 120K | Inches | 4.92  | 4.92  | 2.95 |
|                                      |                    |   |      |  |      | mm     | 125   | 125   | 75   |
| <b>1590WJF</b><br><b>1590WJFBK</b>   | Unpainted<br>Black |    | 113K |    | 140K | Inches | 5.71  | 3.74  | 1.77 |
|                                      |                    |   |      |  |      | mm     | 145   | 95    | 45   |
| <b>1590WP1F</b><br><b>1590WP1FBK</b> | Unpainted<br>Black |    | 119K |    | 199K | Inches | 6.01  | 3.24  | 1.81 |
|                                      |                    |   |      |  |      | mm     | 153   | 82    | 46   |
| <b>1590WDDF</b><br><b>1590WDDFBK</b> | Unpainted<br>Black |    | 130K |    | 314K | Inches | 7.40  | 4.70  | 1.30 |
|                                      |                    |   |      |  |      | mm     | 188   | 119.5 | 33   |
| <b>1590WDF</b><br><b>1590WDFBK</b>   | Unpainted<br>Black |    | 130K |    | 347K | Inches | 7.38  | 4.70  | 2.05 |
|                                      |                    |   |      |  |      | mm     | 188   | 120   | 52   |
| <b>1590WEF</b><br><b>1590WEFBK</b>   | Unpainted<br>Black |    | 126K |    | 213K | Inches | 7.38  | 4.70  | 3.07 |
|                                      |                    |   |      |  |      | mm     | 188   | 120   | 78   |
| <b>1590WFF</b><br><b>1590WFFBK</b>   | Unpainted<br>Black |  | 130K |  | 378K | Inches | 7.38  | 7.38  | 2.48 |
|                                      |                    |   |      |  |      | mm     | 188   | 188   | 63   |
| <b>1590WR1F</b><br><b>1590WR1FBK</b> | Unpainted<br>Black |  | 128K |  | 229K | Inches | 7.55  | 4.38  | 2.24 |
|                                      |                    |   |      |  |      | mm     | 192   | 111   | 57   |



Link here to [photo tables](#) of each part number - **note:** regular, unflanged version shown for sizing

#### NOTES:

- For more detailed drawing of the enclosure refer back to our 1590 series (without flanges) listed above. This allowed more room on the drawings for other details.
- Dimensions are for enclosure (length does not include flanges)

- Add 0.16" (4 mm) to enclosure depth for lid
  - For other drawing information or if you prefer .dwg versions of these drawings e-mail [drawings@hammondmfg.com](mailto:drawings@hammondmfg.com)
  - Available in natural vibra finish OR in light textured, powder paint in Black.
  - This series is the same as our 1590 diecast aluminum except with a bead of rubberlike silicone around the perimeter of the lid.
- 

[DOWNLOAD](#)

catalog pages on this series (132K) [9C-1590WF.pdf](#)

---

Exactly what you are looking for???  
Link to our stocking distributors - most have "on-line" pricing, stock check and ordering!!!

[Our Distributors](#)

Order from your favorite distributor

---

[Home](#) | [Products](#) | [Distributors](#) | [Technical](#) | [Contact Us](#) | [Other Options](#)

---

Top View of Assembly

SECTION A-A  
End View of Assembly

Series 1590DF (Flanged Box)

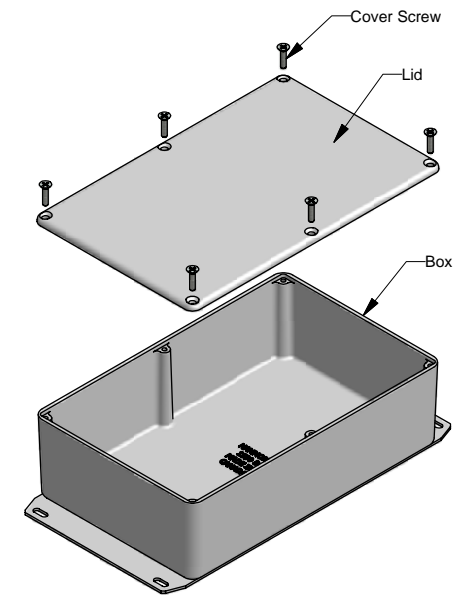
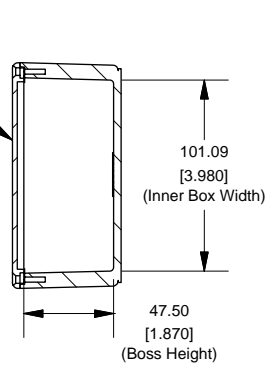
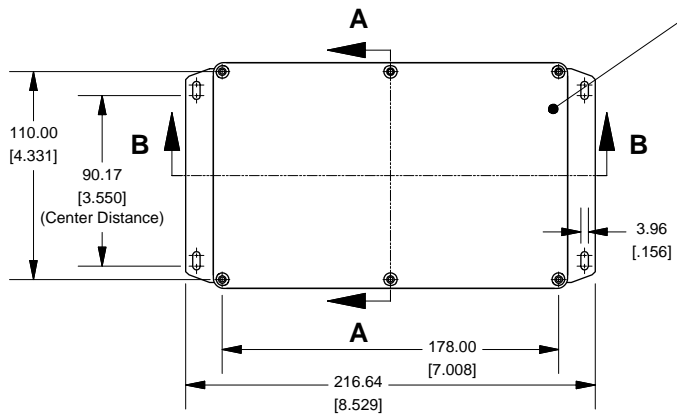

SECTION B-B  
Side View of Assembly

Top View Looking Inside Box

SECTION C-C  
Side View of Slot

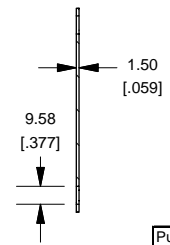
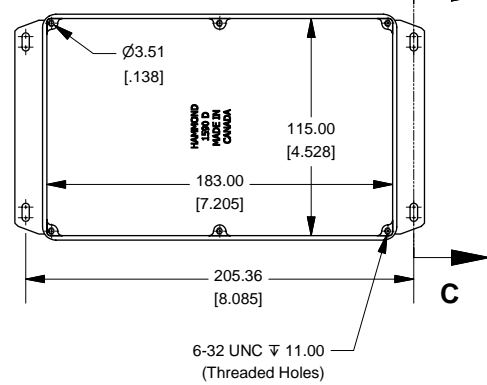
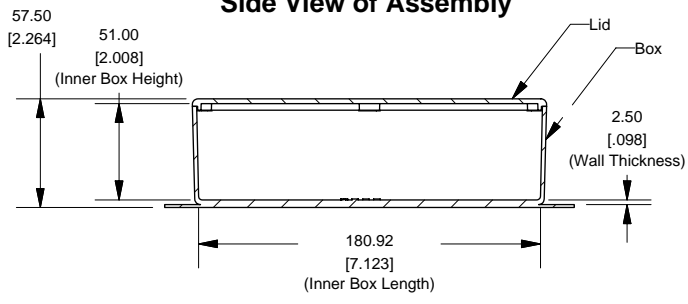

Lid

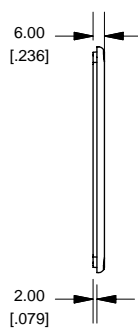
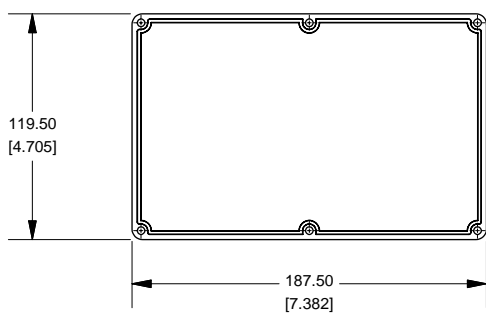

Purchased assembly includes box, lid and 4 cover screws.  
 Box and lid are made from Diecast Aluminum Alloy (alloy type 360.1).  
 Flanges are made from Stamped Aluminum 5052-H32

| PART NUMBERS   |            |
|--|------------|
| 1590DF Enclosure   |            |
| Unfinished   | 1590DF     |
| Black Textured Powder Paint  | 1590DFBK   |
| 1590DF Liquid Resistant Enclosure (Silicon Factory Installed Gasket) |            |
| Unfinished   | 1590WDF    |
| Black Textured Powder Paint  | 1590WDFBK  |
| ACCESSORIES  |            |
| Unfinished   |            |
| Cover Screws (Pkg 100)   |            |
| [6-32 x 1/2" Nickel Plated Screws]                                   | 1590MS100  |
| Black Textured Powder Paint  |            |
| Cover Screws (Pkg 50)  |            |
| [6-32 x 1/2" Stainless Steel Black Screws]                           | 1590MS50BK |

